

# ROADSIDE

SERVICES AND SOLUTIONS



## ENERGY ABSORBING BOLLARD

PRODUCT MANUAL

“Creating a **safer environment**™”

### Our shared vision

Wherever possible, Roadside Services and Solutions chooses suppliers who share our vision and embrace sustainability. This is why Roadside is proud to partner with global companies like 3M which is renowned for its commitment to the environment and is the sole supplier to Roadside of sign sheeting and pavement marking solutions.

# Energy Absorbing Bollard - EAB product manual

Roadside Services and Solutions is a proud producer and distributor of traffic control products, including Energy Absorbing Bollards designed to protect pedestrians, buildings, infrastructure and other facilities from errant vehicles or keep vehicles out of unauthorised areas. A number of these products are also designed to minimise damage to vehicles and injury to occupants.

The range of bollards available suits various situations and a range of speed impacts expected in these situations. They can be used in individual circumstances or in combination with other bollards such as in pedestrian malls. In a worst case scenario the bollards can help protect areas where there are high numbers of pedestrians from deliberate acts intended to injure as many people as possible.

In 2017 Roadside Services and Solutions became the Australian distributor of the most technologically advanced Energy Absorbing Bollard, which has undergone rigorous testing to protect outdoor diners and infrastructure assets. Other Roadside EAPs (Energy Absorbing Products) include the EAB20 – specially designed bollards for public and car parking facilities (tested to 20km/h), the Energy Absorbing Pole/Tree Buffer (rated up to 80km/h) and the globally unique Energy Absorbing Light Pole (remains upright after a 70km/h impact).

The Energy Absorbing Products supplied and installed by Roadside Services and Solutions add to the wholly Australian-owned company's other products, including traffic and safety signs, line-marking, safety products, road and footpath plastic products, carpark and industrial barrier products, and civil construction works.

While most people take these products for granted, there are specific requirements relating to manufacture, installation and placement of these items, all aimed at keeping users safe from hazards.

At Roadside Services and Solutions we are backed by the 3M Diamond Warranty Programme. We have pre-qualification with VicRoads and South Australia's Department of Planning, Transport and Infrastructure, and we regularly supply products to Roads and Maritime Services in NSW, the Northern Territory Government and its preferred contractors.

Roadside Services also has been certified in Quality, the Environment and OH&S.

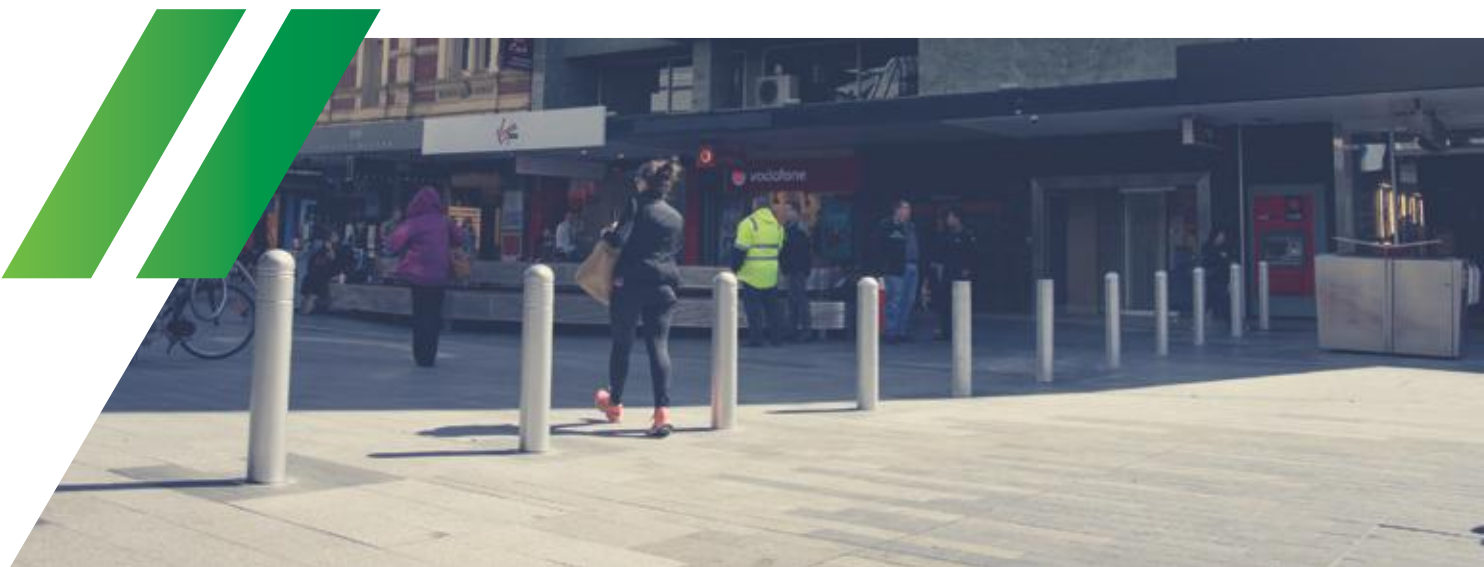

For further information please contact

T 1300 022 222 F 1300 131 111

E [roadside@rss.net.au](mailto:roadside@rss.net.au) W [roadsideservices.com.au](http://roadsideservices.com.au)

© 2019 Roadside Services and Solutions Pty Ltd

## Table of contents

1. Introductory notes
2. System overview
3. Function
4. Preparation
5. Identification
6. Tools required and mandatory PPE
7. Kit contents
8. Recommendations
9. Performance
10. Installation instructions
11. Repair and maintenance
12. Main components and dimensions
13. EAB spacing and clear zone
14. EAB - Energy Absorbing Bollard registration form
15. Notes



# 1. Introductory notes

The Energy Absorbing Bollard (EAB) has been designed and tested for installation in places to protect pedestrians from errant vehicles and from damaging buildings and infrastructure.

The EAB's performance is critically dependant on correct installation. This manual is designed to assist with ensuring the correct installation of the EAB.

Over time, EABs may require maintenance. This will depend on the location they are fitted and if they have been damaged by an out-of-control vehicle.

It is imperative installation crews are fully familiar with the installation instructions. This manual must be reviewed carefully before any work begins and if necessary, additional information and assistance can be obtained from Roadside Services and Solutions engineering staff.

# 2. System overview

The EAB is classified as a non re-directive crash attenuator tested under AS/NZS:3845:1999, Table 5.3.3(3) for a 1600kg vehicle impact at 60km/h. This product conforms to AS/NZS:3845:1999

# 3. Function

The EAB has been designed to safely decelerate and stop an out-of-control vehicle. The EAB cartridge progressively deforms on impact and absorbs the kinetic energy of the out-of-control vehicle.

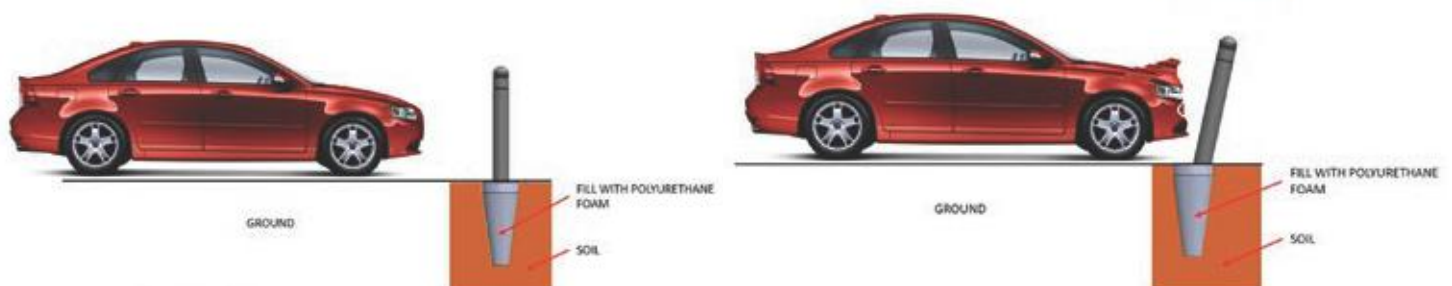

## 4. Preparation

Before any attempt is made to begin the installation of an EAB, it is important to read and fully understand the installation instructions. This will ensure correct installation and minimise possible errors which can compromise the performance of the EAB. Before soil excavation begins, it is critical to locate all underground services.

A plan / plans of the underground services can be obtained from Dial Before You Dig. Using the plans and an experienced locator, all underground services (gas pipes, phone cables and water pipes) must be clearly marked on the surface of the road / footpath where the work will be undertaken. Water jets and vacuum trucks are the preferred method for excavation. An auger could cause extensive damage to the underground services if not detected before works start.



While underground infrastructure plans supplied from Dial Before you Dig provide the best available public information, the risk of unidentified services not marked on the plans is a reality.

Therefore, extra care must be taken when excavating for the installation of EABs.

## 5. Identification

The EAB is classed as a discrete crash cushion, tested to AS/NZS 3845:1999 Table 5.3.3 (3). The EAB must have a compliance permanent sticker featured prominently to identify the manufacturer and standard to which the EAB complies.



## 6. Tools required and mandatory PPE

The following tools are typically required, although in some locations this may change, depending on the circumstances.

- High water pressure jet / vacuum truck
- Auger or digging tools
- Spirit level
- String line
- Road marking paint
- 1/2 Besser block or high density foam block
- 32MPa concrete
- Crowbar
- Shovel
- Broom



## 7. Kit content

The EAB should be positioned to provide the maximum protection for pedestrians.

The EAB can be used as:

A single EAB to protect an area and should be positioned at least 500mm away from the area boundary.

A line of EABs should be arranged as shown on the diagram on Page 12 of this manual with the spacing between the EABs to be the safest arrangement for the area at risk.

Risk assessment must be conducted to ensure the optimum outcome.



The EAB can be fitted with a lifting ring (see picture below) and if removed a cover plate must be placed over the hole in the cartridge as protection for the public and the cartridge below.



## 8. Recommendations

To shield a concrete road barrier, steel road barriers or a rigid object, ensure the EAB is placed no further than 500mm from the object. This will significantly increase the probability the out-of-control vehicle will hit an EAB and not the hazardous object.

When installing a line of EABs for a temporary work zone, consideration should be given for the ability of an out-of-control vehicle to enter the protected area. It is recommended a risk assessment be conducted, to determine the appropriate distance required in a line of EABs. Refer to section 12 of this manual.







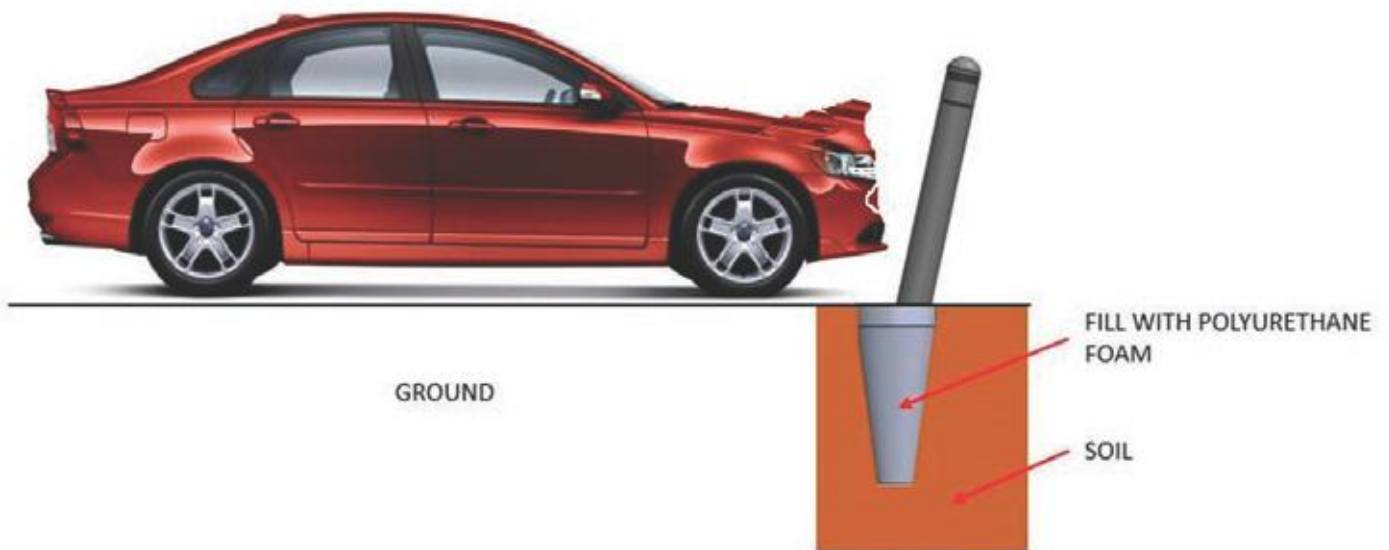

## 9. Performance

The EAB will perform equally in soil, concrete, asphalt or paved surfaces providing the correct installation procedure is followed. See Page 8 of this manual. The material used for the top surface of the energy absorbing cartridge must be comparable strength or softer than the 25mm thick non-bonded pavers. Much stronger and thicker materials (like 32MPa concrete more than 25mm thick) might affect the crash characteristics of the EAB performance in the impact conditions.











# 10. Installation instructions

ITEM	ACTIVITY	ACCEPTANCE CRITERIA	PICTURE
1	Preparation	Before soil excavation begins, locate all underground services. The underground services plans can be obtained from Dial Before You Dig. An experienced locator will identify all underground services (gas pipes, phone cables, water pipes, etc ) from the plan and clearly mark these on the surface of the road or footpath. Water jets and vacuum trucks are preferred for excavation, rather than an auger which could cause extensive damage to obscured underground services. Correct PPE must be worn at all times during the installation. Refer to SWMS.	
2	Site preparation	Mark out where the hole centres are to be dug or excavated. Follow the site design.  NOTE: It is recommended spacing be 600mm from the curbing, this may vary slightly depending on the job requirements.	
3	Site preparation	If installing a line of bollards, use a string line to check the bollards are in a straight line.  NOTE: Ensure the ITP has been checked for the correct locator to avoid hitting any services.	
4	Dig holes  Use water jet vacuum truck or auger	Excavate a 1000mm deep x 600mm diameter wide hole.  NOTE: If using machinery refer to the SWMS for the safe operating procedure.  NOTE: Water jet and vacuum truck are the preferred method for excavation, rather than an auger which could cause extensive damage to the obscured underground services.	
5	Concrete holes	Place the HD foam block or 1/2 a Besser brick in the centre of the hole and place the Roadside energy absorbing cartridge on top of the foam or brick.  NOTE: The smaller end of the cartridge must be at the bottom of the hole to ensure correct bollard performance.	
6	Position cartridge	Insert the cylinder of the reo cage around the cartridge. Ensure the cage is at equal distance around the cartridge. Pour concrete into the space surrounding the cartridge to approximately 300mm.  NOTE: Concrete should be 32Mpa strength concrete at a 70mm slump mix.	



# 10. Installation instructions

ITEM	ACTIVITY	ACCEPTANCE CRITERIA	PICTURE
7	Position cartridge	Use a spirit level to ensure the cartridge is correctly positioned.  NOTE: Using a 150mm x 1450mm light-weight galvanised pipe placed into the cartridge to check the bollards will be vertical will be helpful.	
8	Pour concrete	Fill the remainder of the hole with a minimum 32MPa strength concrete.  NOTE: If the cartridge is to be covered with concrete or asphalt, the covering depth must not exceed a depth of 30mm. The cartridge may be covered with non bonded pavers to a depth of 50mm.	
9	Place bollard	Install the bollard once the concrete is dry by placing the Roadside EAB in the centre of the cartridge and lowering approximately 400mm on to the cross-bar.  The material used for the top surface over the energy absorbing cartridge must be comparable strength or softer than the 25mm thick non bonded pavers. Much stronger and thicker materials (like 32MPa concrete more than 25mm thick) may affect the crash characteristics of the EAB performance when impacted.	
10	Replace pavement	Finish by screeding the concrete surface and if applicable replace pavers around the installed bollard.	
11	Finish	Clean and sweep up any excess dirt or debris from the site.	
12	Ensure	Installers complete the Roadside EAB Registration Form and email it to: roadside@rss.net.au	

## 11.0 Repair and maintenance

In the event of an out-of-control vehicle impacting the EAB it is important to visually examine the damage at the earliest opportunity.

Damaged paintwork is usually a sign the EAB has been impacted.



### 11.1

Next step is to examine damage to the foundation below the surface cartridge.

Any significant damage to the cartridge will result in the above-the-ground bollard not being straight.

### 11.2

The bollard needs to be removed from the cartridge.



### 11.3

The concrete footing needs to be broken using a jack hammer and crowbar.

### 11.4

After the damaged footing is removed, install a new cartridge, reo cage and fill with 32MPa concrete to repair the damaged footing.



## Note:

If a steel bollard is involved in an accident and does not have visible deformation (not bent) despite paint damage, the bollard can be used again after it is cleaned and repainted. If any visible deformation of the steel bollard is detected, then a new steel bollard must be installed.

# 12. Main components and dimensions

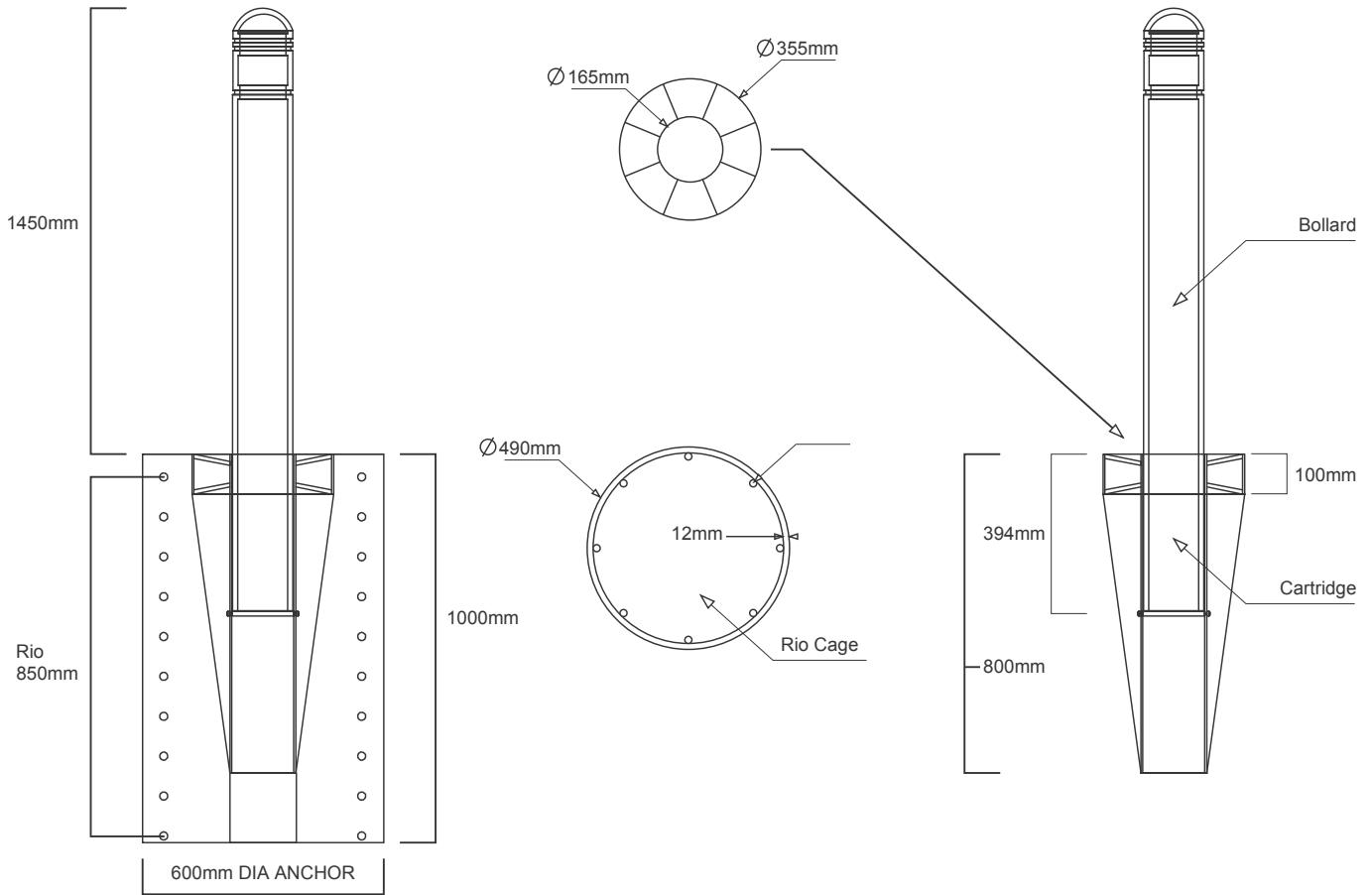

EAB installation weights and dimensions				
	Bollard, cartridge, reo cage	Bollard only	Cartridge only	Reo Cage only
Diameter	450mm	150mm	355.6mm	450mm
Length	1850mm	1450mm	800mm	800mm
Weight	120.3kg	67.5kg	28.5kg	24.5kg

# 13. EAB spacing and clear zone

When EABs are installed in a row, consideration must be given to the location and a clear zone prepared around the site. A site safety and risk assessment should be conducted to identify all possible impact directions before a recommendation is confirmed for the installation spacing. The different scenarios are provided below as a general guide only.

Recommended placements at bridge abutments.

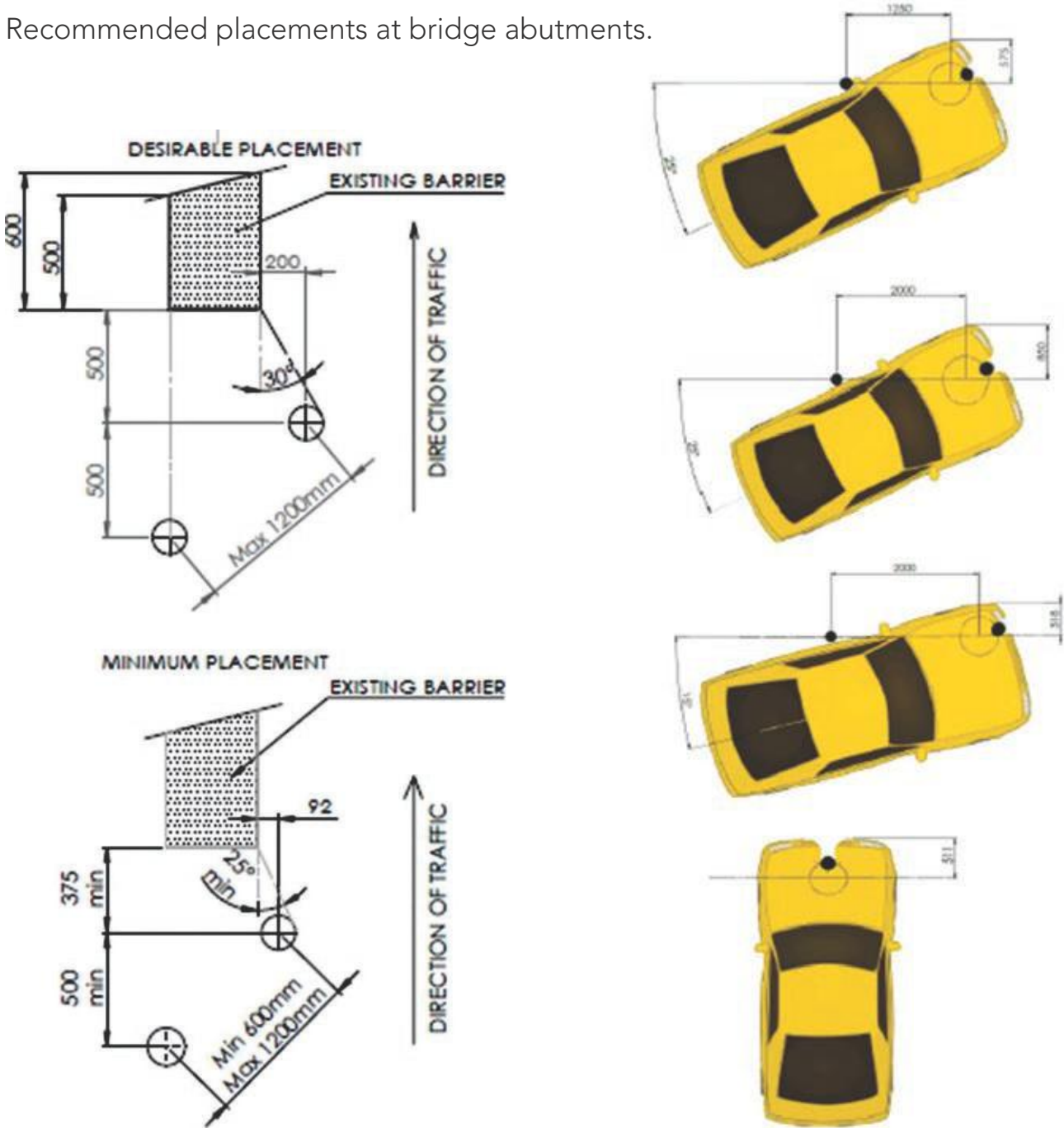



# 14. EAB - Energy Absorbing Bollard registration form

**NOTE:** Correct installation of the EAB is imperative to ensure performance under impact conditions. All installers of the EAB, **MUST** adhere to the following installation requirements and confirm in writing the installation documentation in the Roadside Services and Solutions EAB Product Manual has been strictly followed.

The following details are required:

Name of company installing the EAB: \_\_\_\_\_

Installation site: \_\_\_\_\_

Installation date:

/	/
---	---

1. "Dial Before You Dig" contacted and plans have been sourced.

Y	/	N
---	---	---

2. Service location checks carried out. Proof required.

Y	/	N
---	---	---

3. Correct reo cage installed 450mm x 800mm x 12N spiral.

Y	/	N
---	---	---

4. Concrete used is 32MPa grade @ 70mm slump.

Y	/	N
---	---	---

5. Concrete over the top of cartridge is not more than 25mm thick.

Y	/	N
---	---	---

6. Surface around EAB reinstated to customer's specifications.

Y	/	N
---	---	---

Please email signed form to: [roadside@rss.net.au](mailto:roadside@rss.net.au)

Installer's signature: \_\_\_\_\_

Print name: \_\_\_\_\_

Mobile number: \_\_\_\_\_

Email: \_\_\_\_\_

Additional comments about the installation:

\_\_\_\_\_

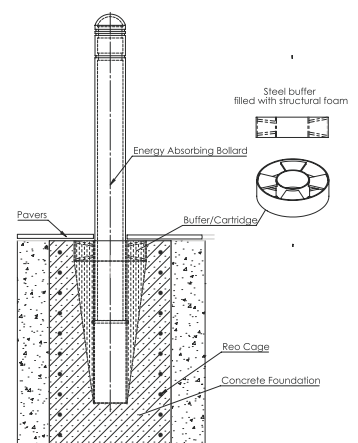

**Important Note:** Do not substitute any parts or fix any other object without first consulting Roadside Services and Solutions. Substituting any part or introducing a non-approved part may reduce the effectiveness of the Energy Absorbing Bollard and performance cannot be guaranteed.





# 15. Notes



For further information please contact  
T 1300 022 222 F 1300 131 111  
E [roadside@rss.net.au](mailto:roadside@rss.net.au) W [roadsideservices.com.au](http://roadsideservices.com.au)

